



HAPPINESS IS MADE OF WOOD



Art. Nr. 11610

Training Bike and Trike Turquoise

Assembly instruction

Laufraud und -dreirad Türkis

Aufbauanleitung

Draisienne et Tricycle Turquoise

Notice de montage

Bicicletta e triciclo turchese

Istruzioni di montaggio

Bicicleta y triciclo, turquesa

Instrucciones de montaje

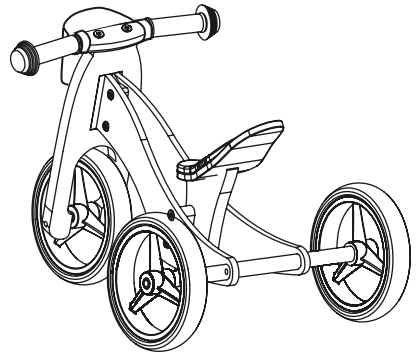

WARNING! Protective equipment should be worn. Not to be used in traffic. To be used under the direct supervision of an adult. Keep this information. | **ACHTUNG!** Mit Schutzausrüstung zu benutzen. Nicht im Straßenverkehr zu verwenden. Benutzung unter unmittelbarer Aufsicht von Erwachsenen. Hinweise aufbewahren. | **ATTENTION!** Il convient de porter un équipement de protection. Ne pas utiliser sur la voie publique. À utiliser sous la surveillance rapprochée d'un adulte. Conserver ces indications. | **AVVERTENZA!** Si raccomanda di indossare un dispositivo di protezione. Non usare nel traffico. Da usare sotto la diretta sorveglianza di un adulto. Conservare le indicazioni. | ¡**ADVERTENCIA!** Conviene utilizar equipo de protección. No utilizar en lugares con tráfico. Utilícese bajo la vigilancia directa de un adulto. ¡Guarda instrucciones!



CAUTION:

The toy is to be assembled by an adult.



CAUTION:

Assemblage par un adulte requis.



WARNING:

CHOKING HAZARD

Small parts. Not for children under 3 years.



AVERTISSEMENT:

RISQUE DE SUFFOCATION

Présence de petits éléments. Ne convient pas aux enfants de moins de 3 ans.



small foot GmbH & Co. KG
Achimer Straße 5
27755 Delmenhorst / Germany
info@small-foot.de
www.small-foot.de



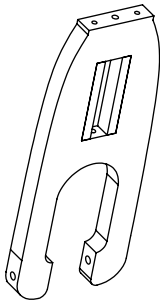
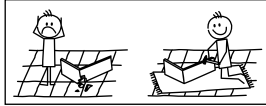
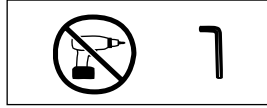
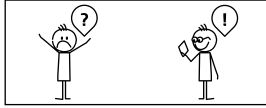

A x 1

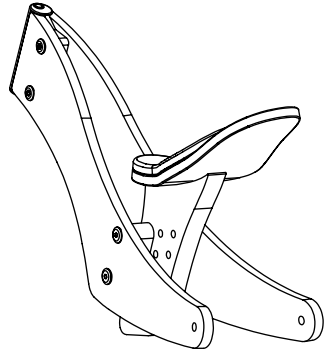

B x 1

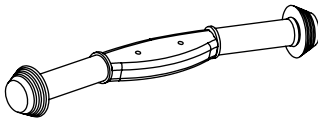



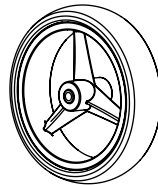





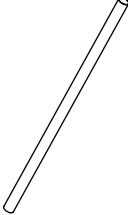
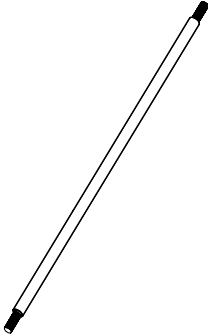
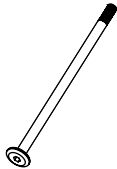



C x 1



D x 3

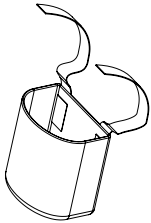

 <p>E x 1</p>	 <p>F x 1</p>	 <p>a x 1</p>	 <p>b x 1</p>	
 <p>c x 2</p>	 <p>d x 2</p>	 <p>e x 2</p>	 <p>f x 2</p>	 <p>g x 2</p>
 <p>h x 2</p>	 <p>i x 1</p>	 <p>j x 2</p>	 <p>k x 1</p>  <p>x 2</p>	 <p>x 1</p>

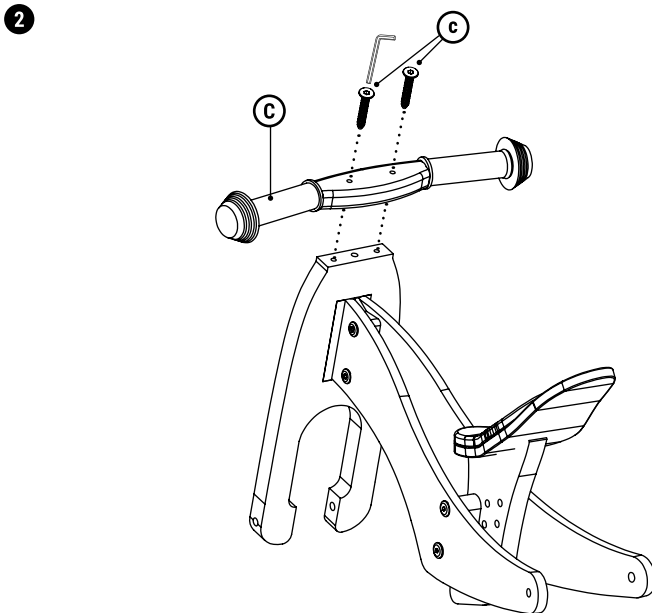
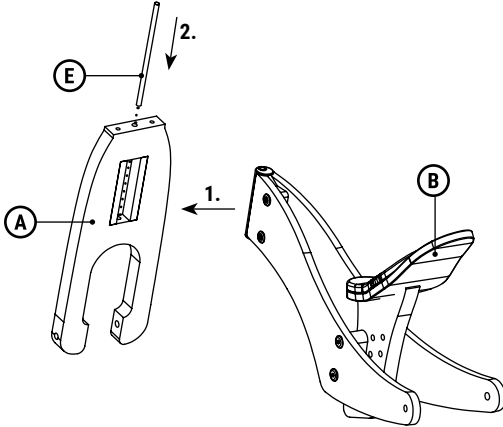
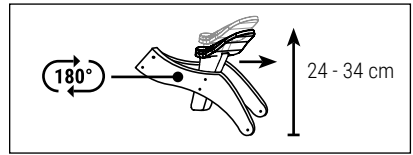
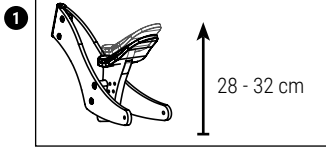

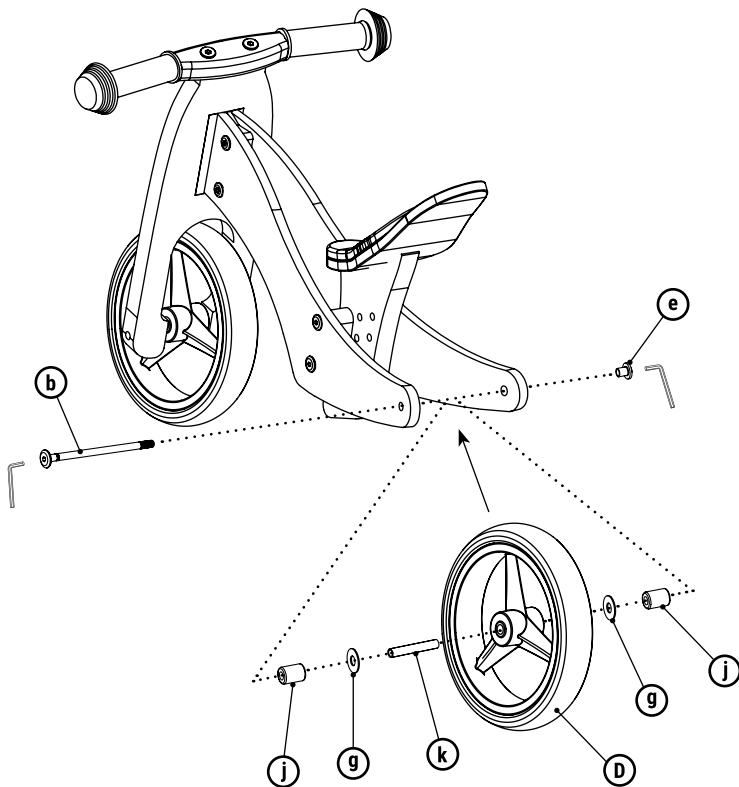
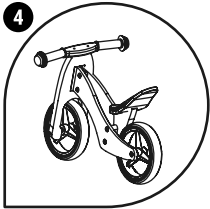

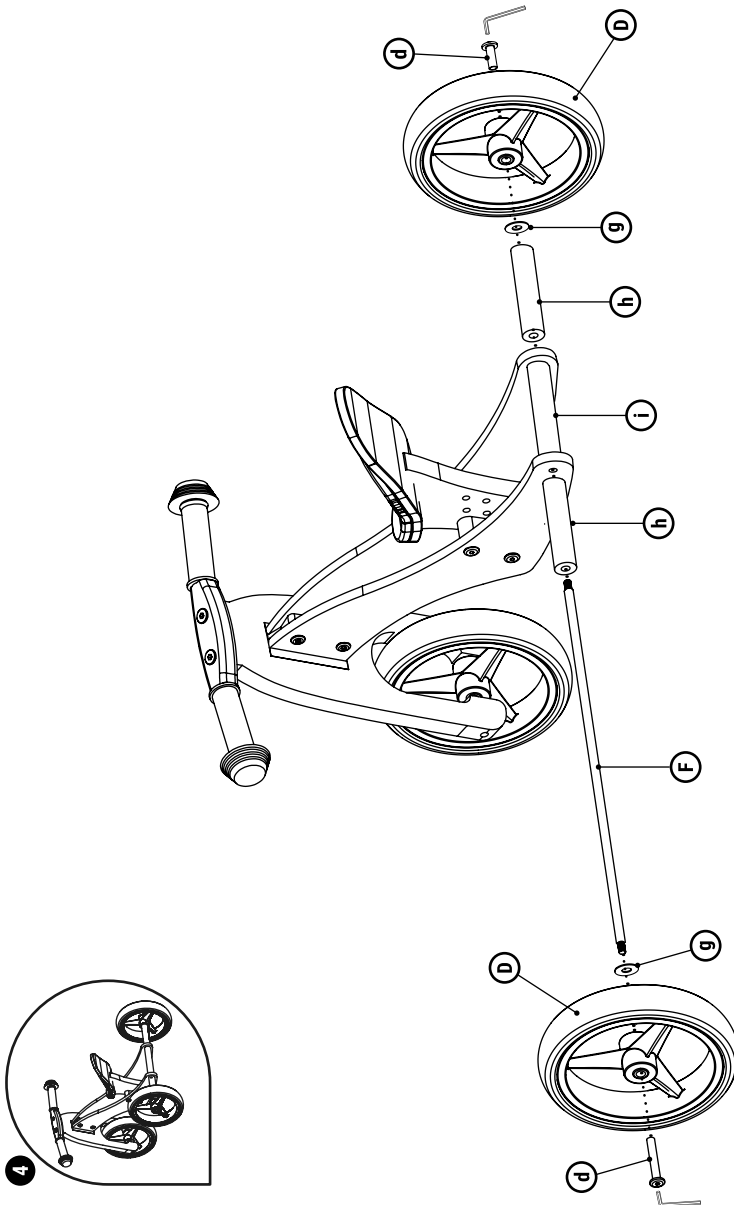

WARNING! Adult assembly required. | ACHTUNG! Aufbau nur durch einen Erwachsenen. | ATTENTION! Assemblage par un adulte requis. | AVVERTENZA! Richiesto assemblaggio da parte di un adulto. | ADVERTENCIA! Se requiere ensamblaje por un adulto.

5

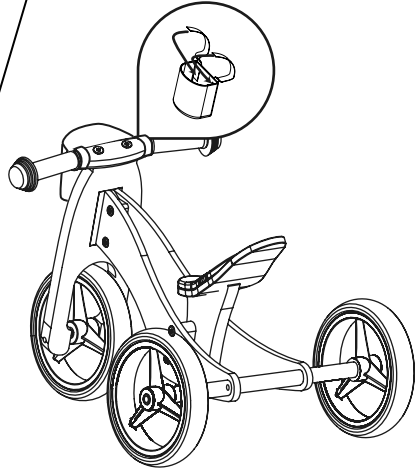
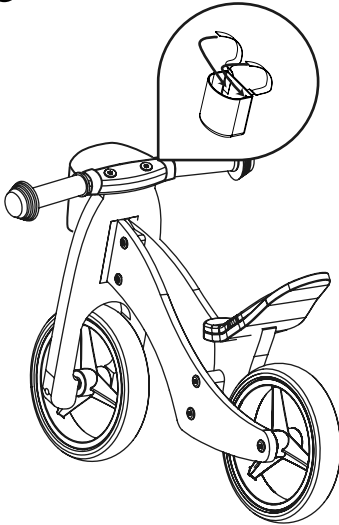

- en** Please keep the remaining parts in a safe place for a later conversion from trike to balance bike.
- de** Bitte die übrigen Teile für einen späteren Umbau vom Trike zum Laufrad gut aufbewahren.
- fr** Veuillez bien conserver les autres pièces pour une transformation ultérieure de la tricycle en draisienne.
- it** Si prega di conservare le parti in esubero per un successivo montaggio da triciclo a bicicletta.
- es** Por favor, guarde las piezas sobrantes para su posterior montaje de triciclo a bicicleta.